



# ***Post-order Traversals***

Prof. Harish D.G.

Dept. of Computer and IT

College of Engineering, Pune (COEP)

[www.harishgadade.com](http://www.harishgadade.com)



# Binary Tree Traversals

## 1. Binary Tree Traversals

- Inorder Traversal
- Preorder Traversal
- Postorder Traversal



### Postorder Algorithm (LRV)

1. Traverse the Left sub-tree in postorder
2. Traverse the Right sub-tree in postorder
3. Visit the root

### 3. Post-Order Traversals (LRV)

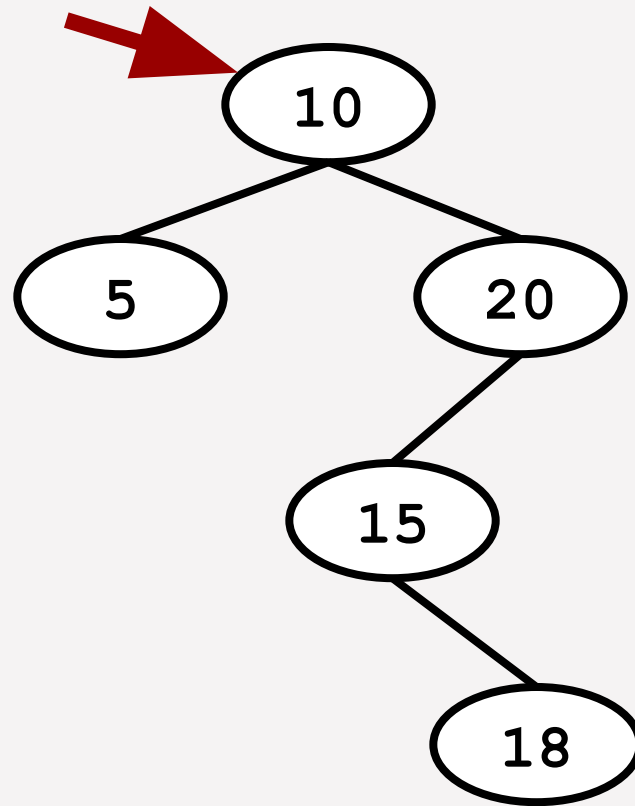

Output :

### 3. Post-order Traversals (LRV)

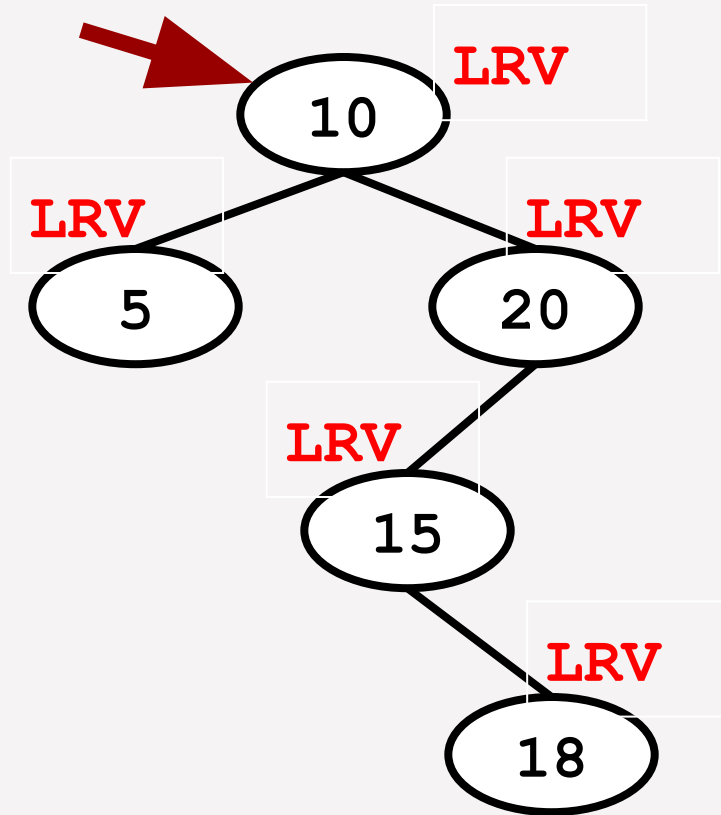

Output :

### 3. Post-order Traversals (LRV)

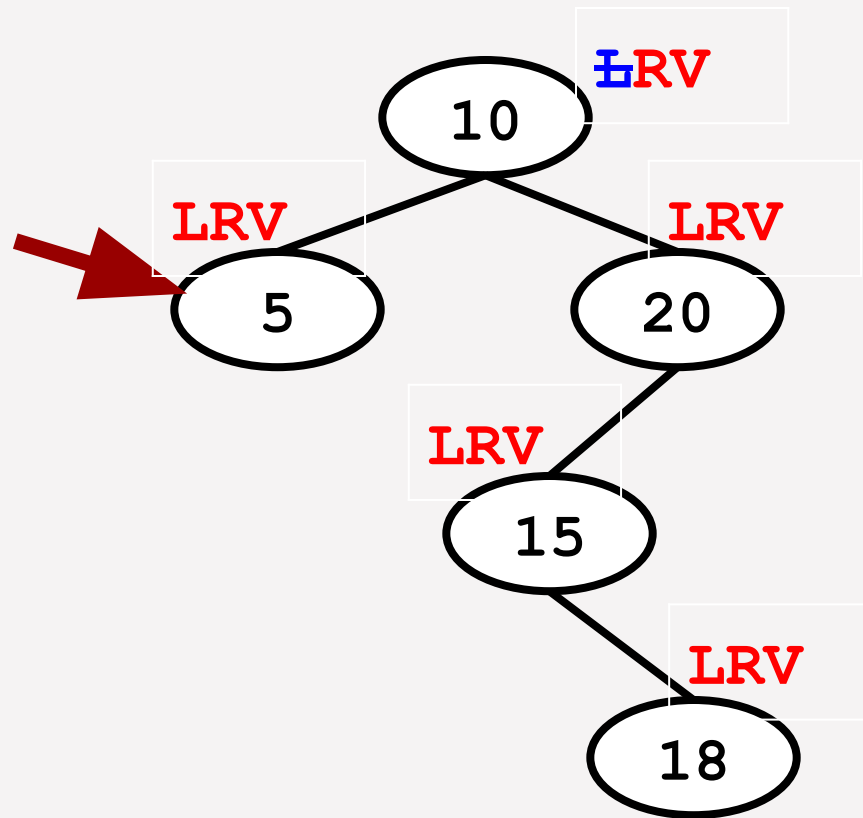

Output :

### 3. Post-order Traversals (LRV)

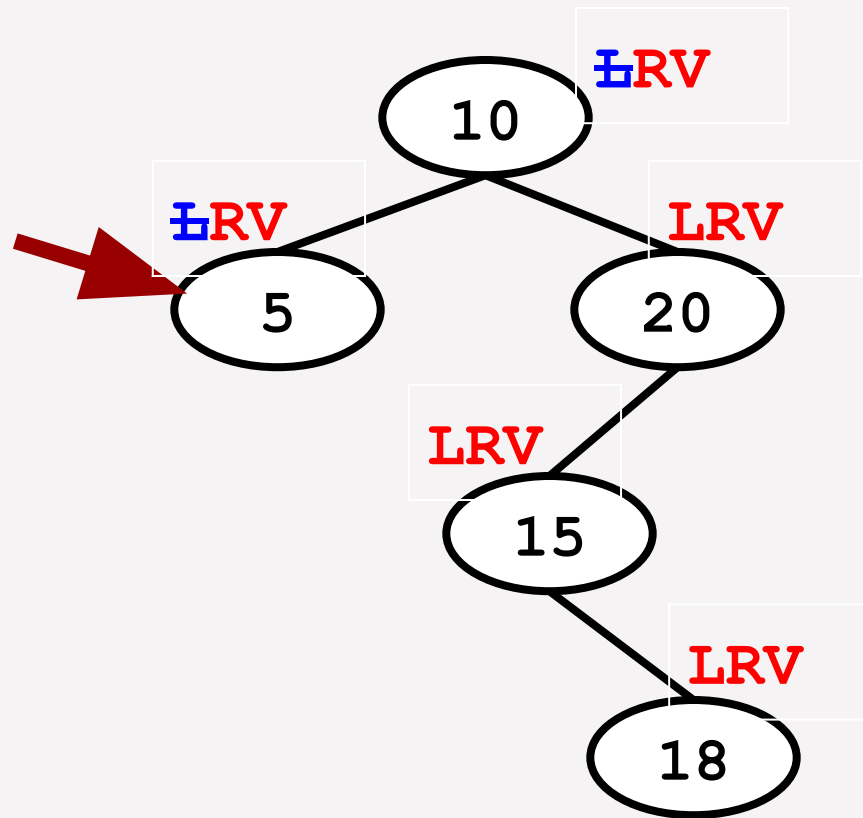

Output :

### 3. Post-order Traversals (LRV)

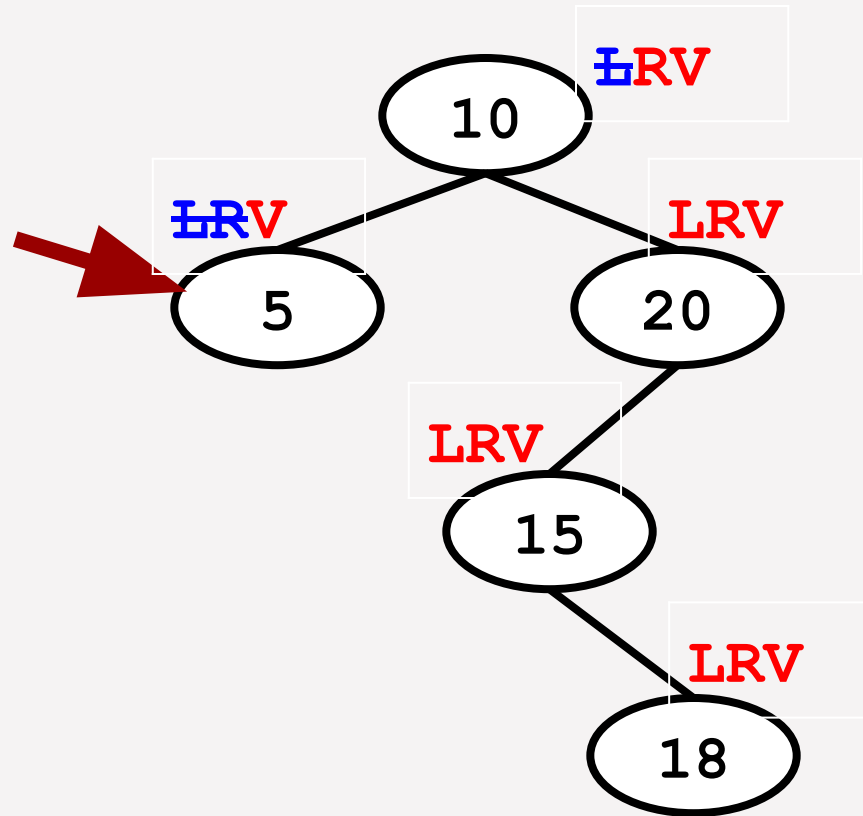

Output :

### 3. Post-order Traversals (LRV)

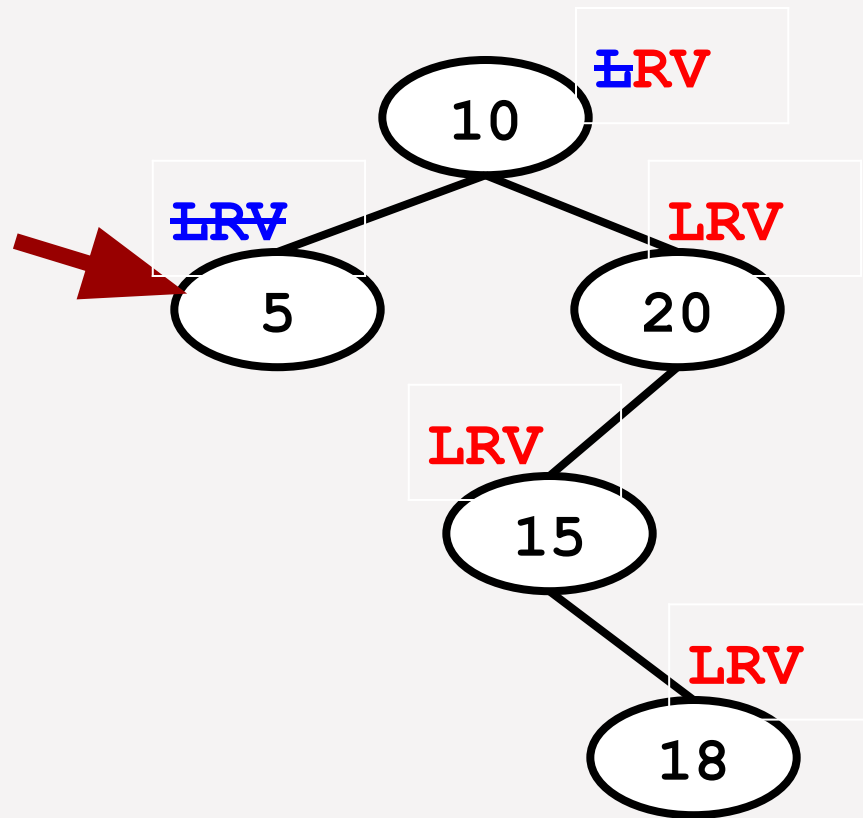

Output : 5



### 3. Post-order Traversals (LRV)

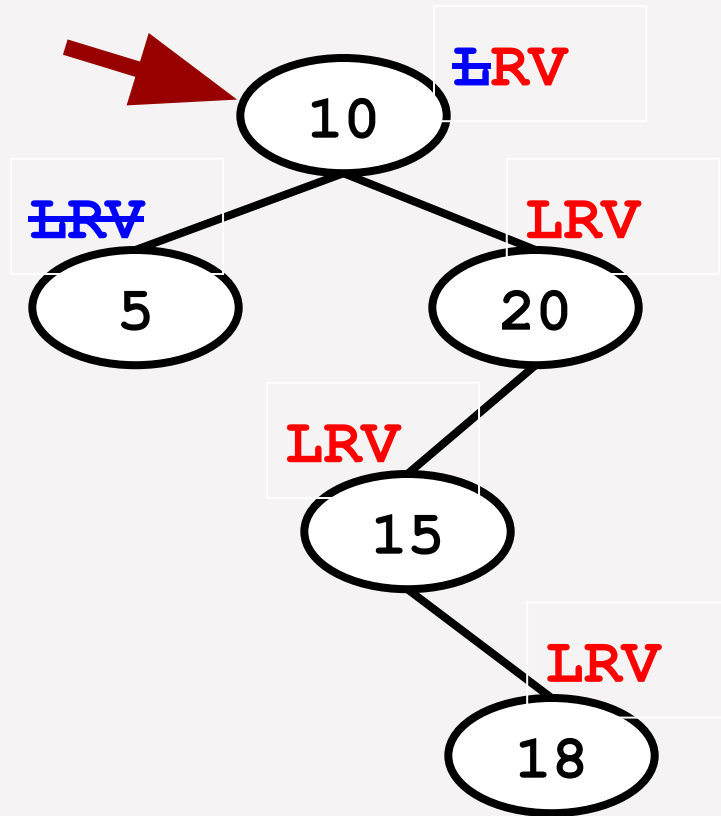

Output : 5

### 3. Post-order Traversals (LRV)

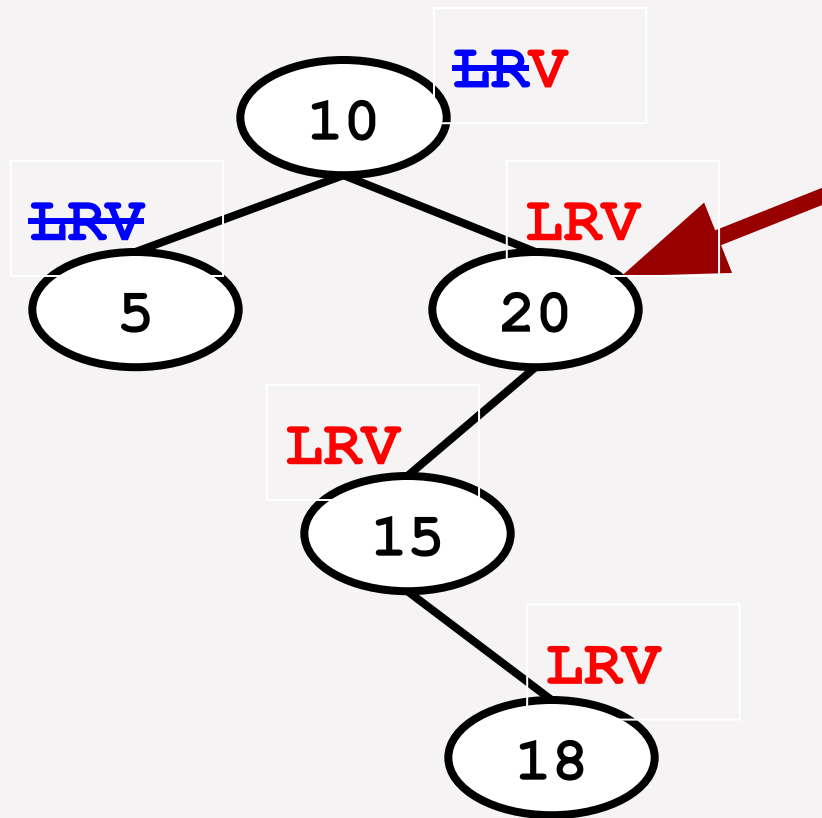

Output : 5

### 3. Post-order Traversals (LRV)

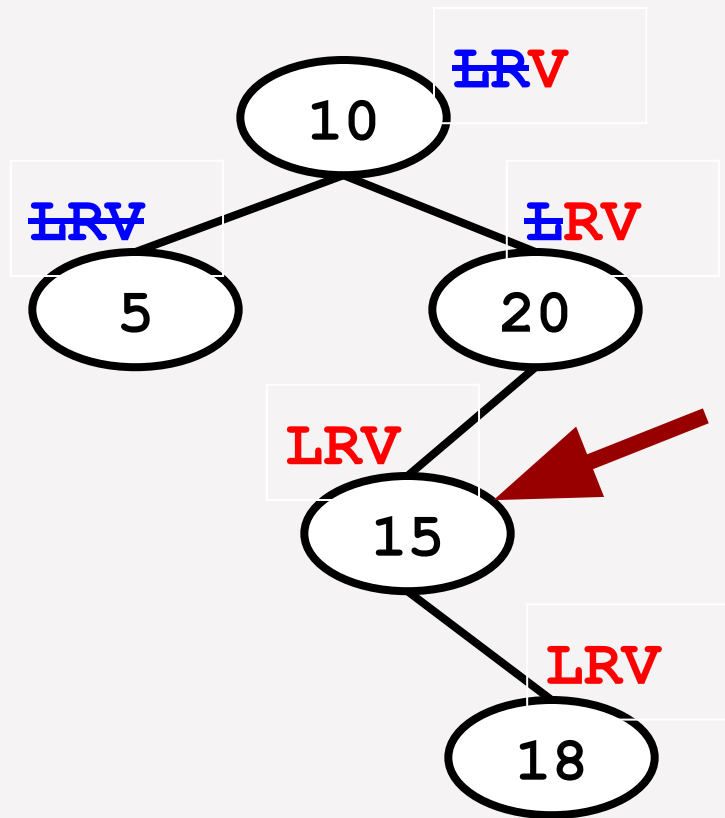

Output : 5

### 3. Post-order Traversals (LRV)

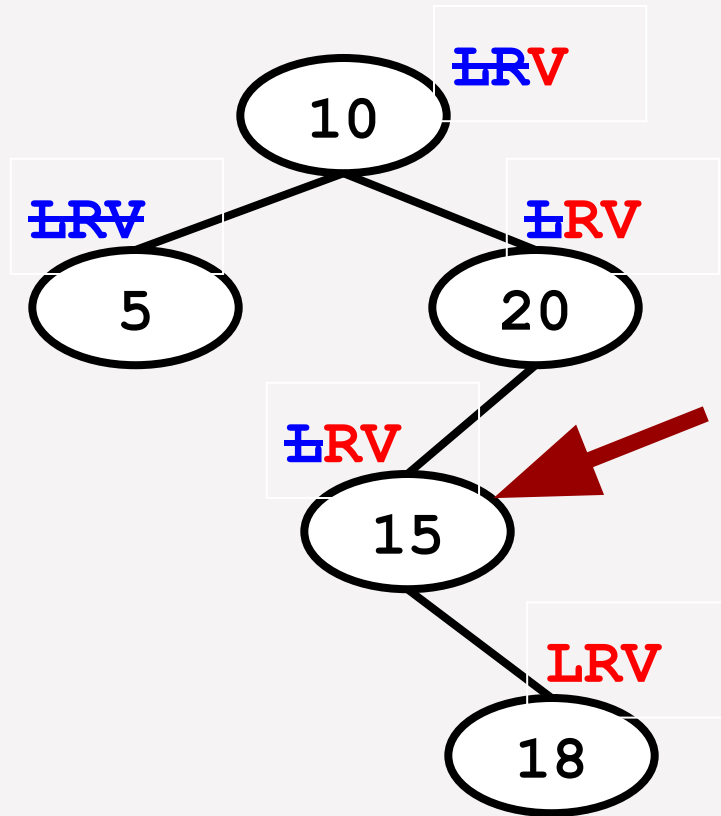

Output : 5

### 3. Post-order Traversals (LRV)

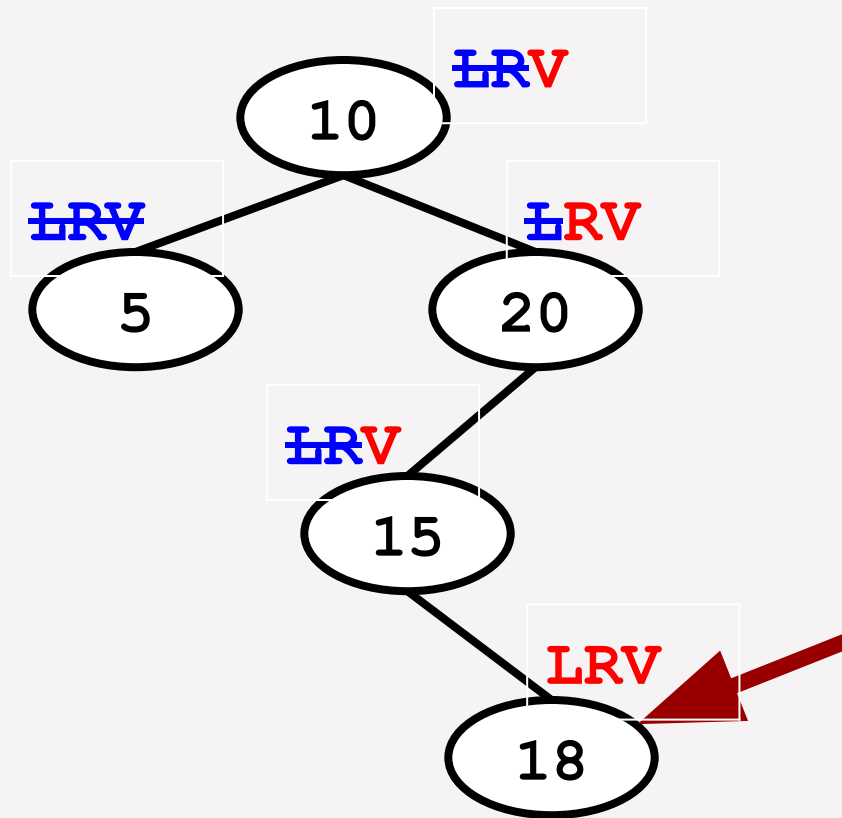

Output : 5

### 3. Post-order Traversals (LRV)

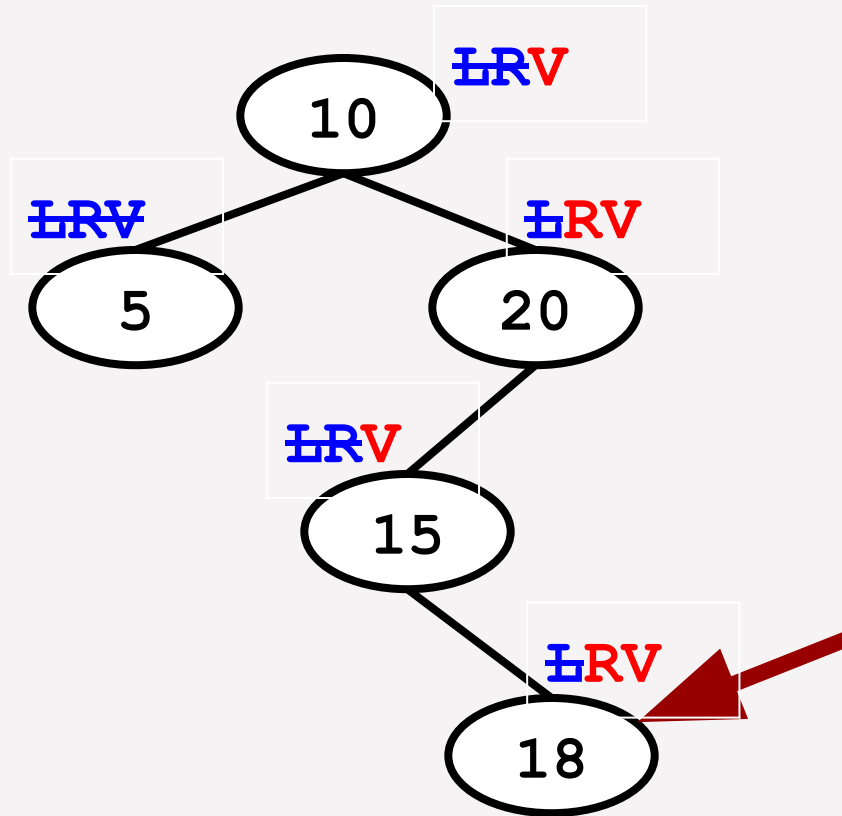

Output : 5

### 3. Post-order Traversals (LRV)

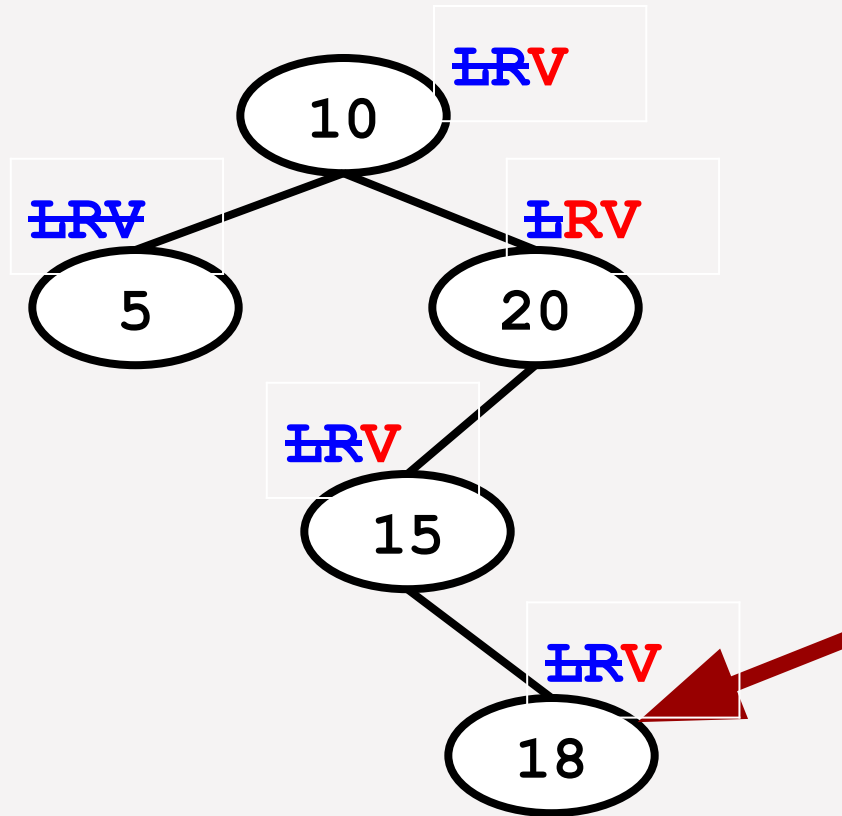

Output : 5

### 3. Post-order Traversals (LRV)

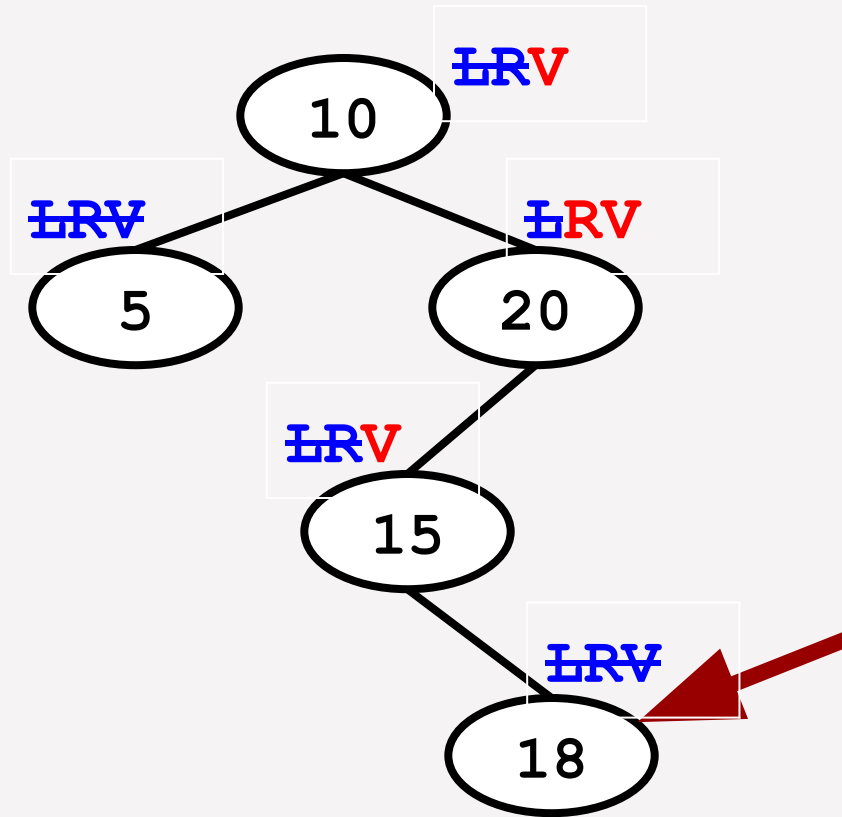

Output : 5, 18



### 3. Post-order Traversals (LRV)

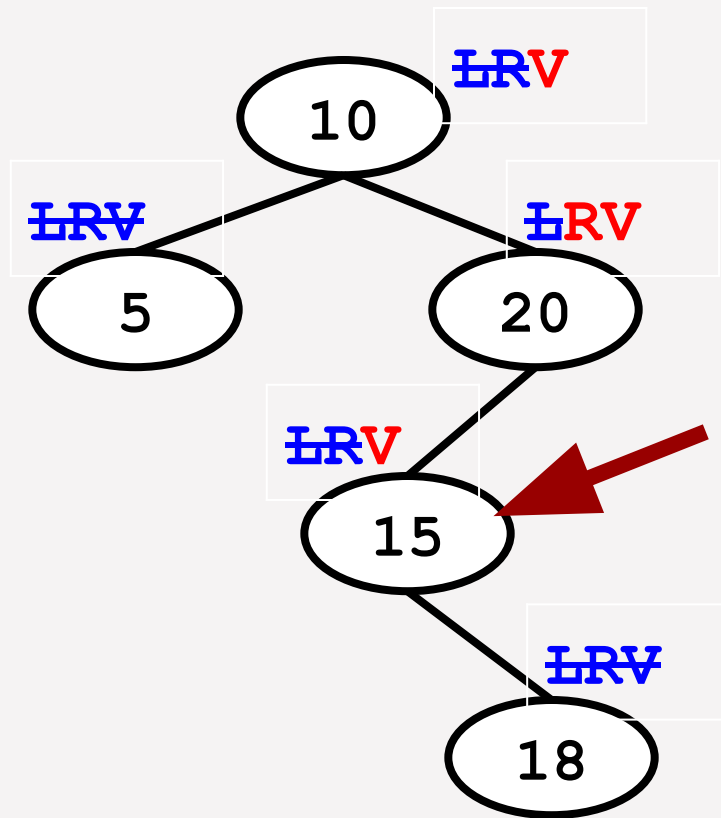

Output : 5, 18

### 3. Post-order Traversals (LRV)

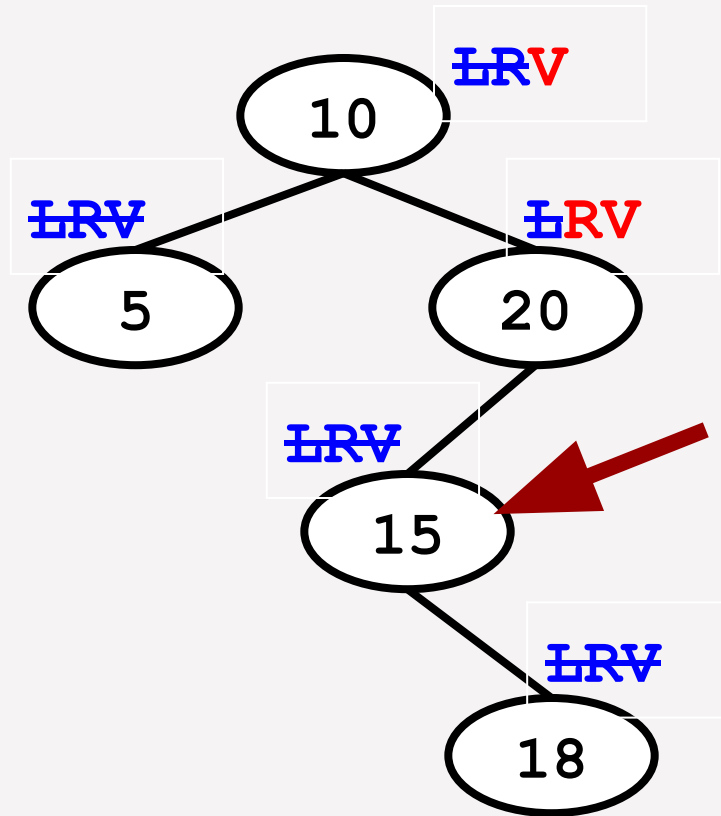

Output : 5, 18, 15

### 3. Post-order Traversals (LRV)

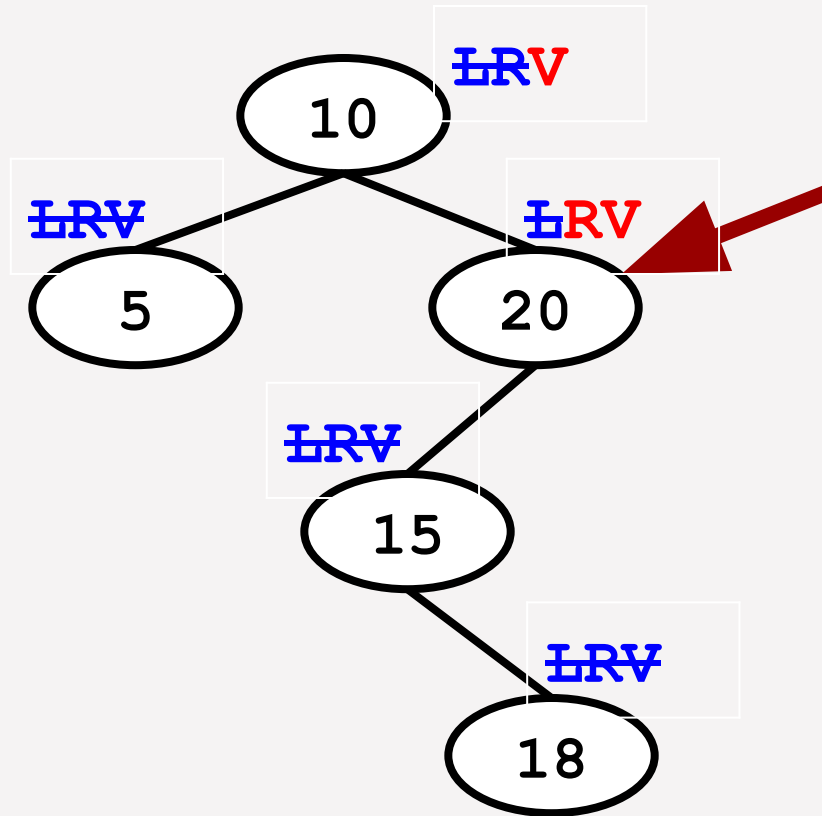

Output : 5, 18, 15

### 3. Post-order Traversals (LRV)

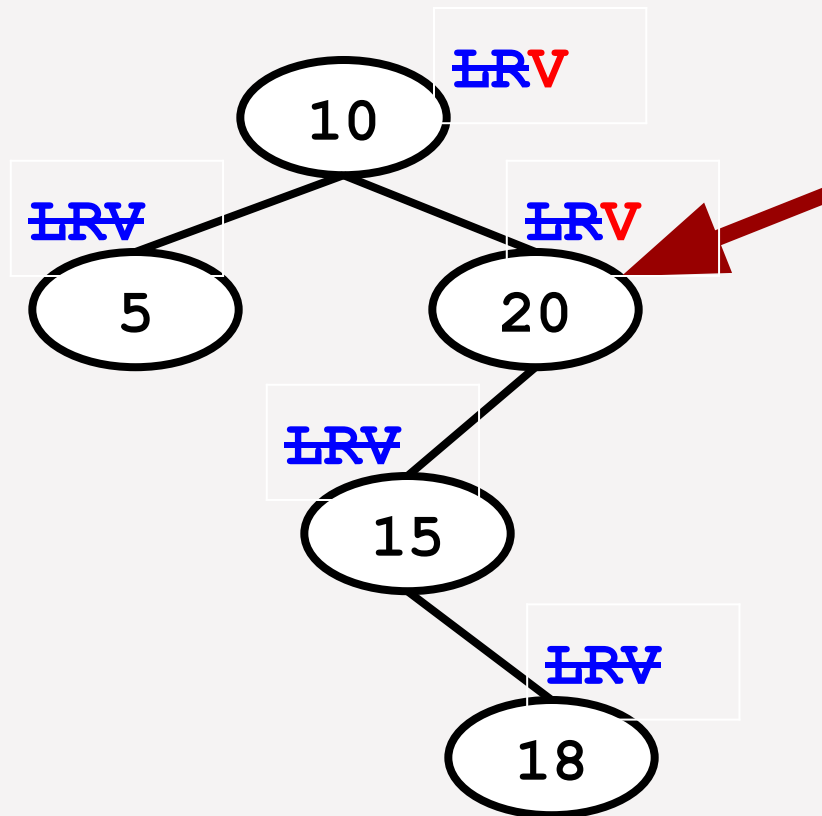

Output : 5, 18, 15

### 3. Post-order Traversals (LRV)

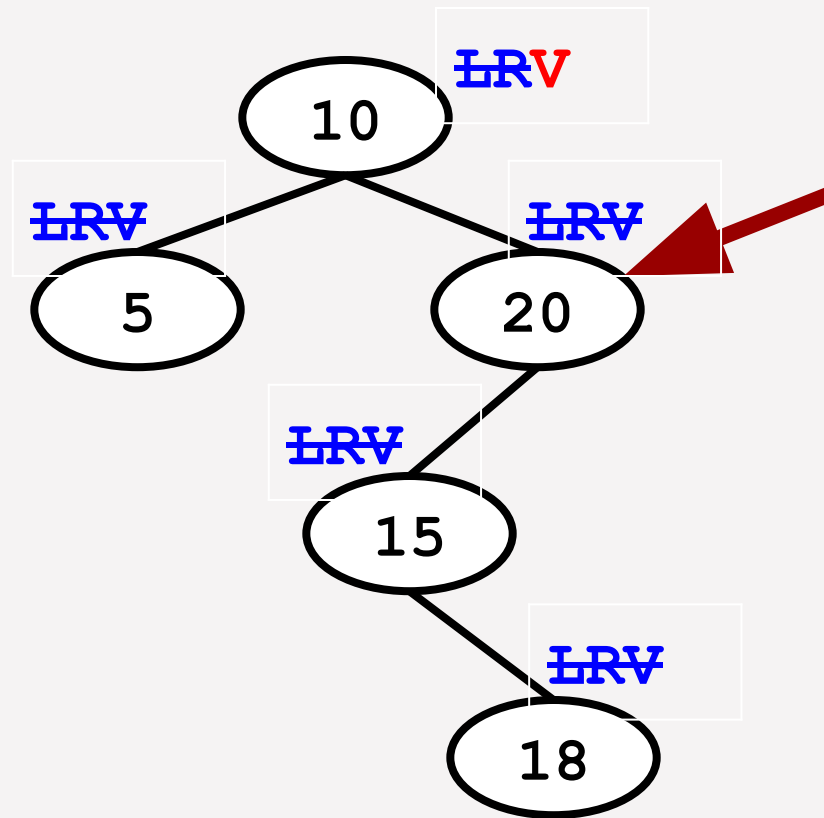

Output : 5, 18, 15, 20

### 3. Post-order Traversals (LRV)

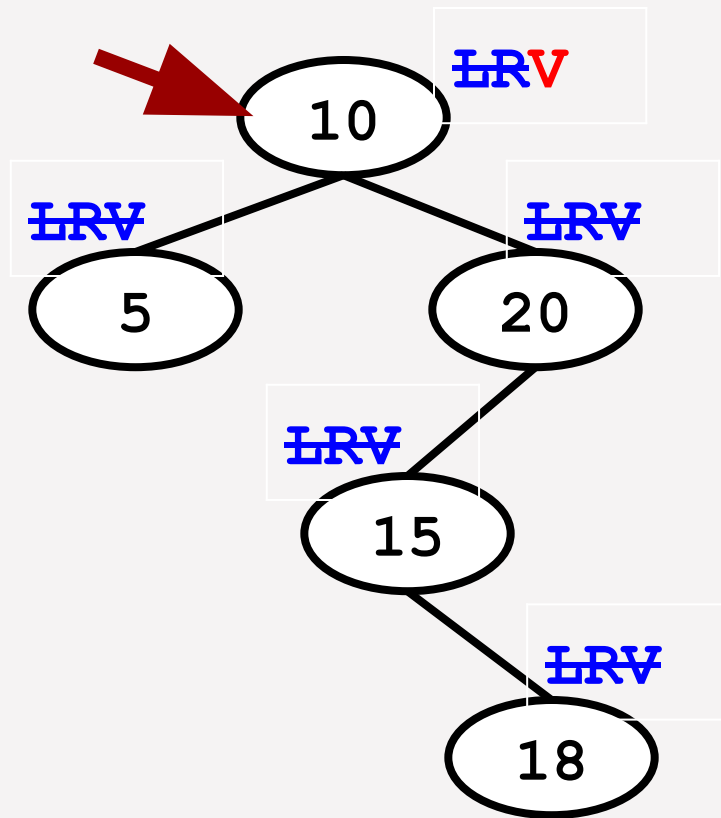

Output : 5, 18, 15, 20

### 3. Post-order Traversals (LRV)

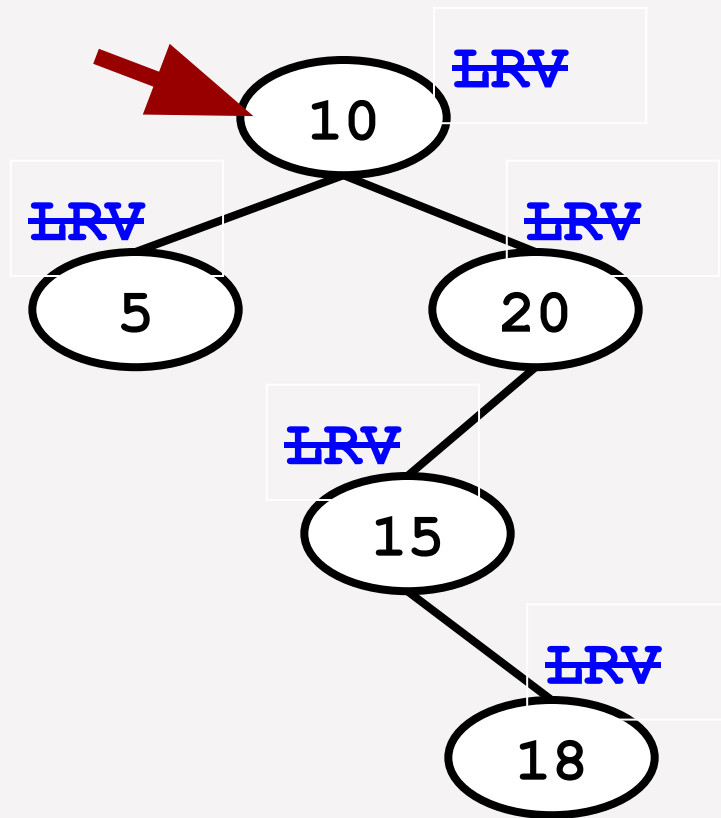

Output : 5, 18, 15, 20, 10

### 3. Post-order Traversals (LRV)

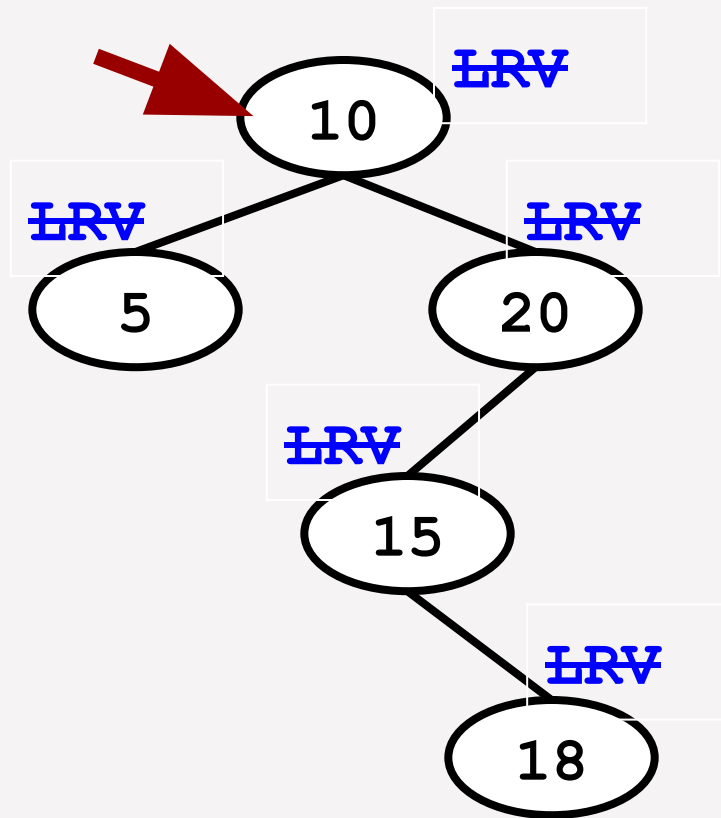

**Output : 5, 18, 15, 20, 10**

**Final Post-Order Traversals**